

**ZXCT1082/83/84/85/86/87**  
**PRECISION HIGH VOLTAGE HIGH-SIDE CURRENT MONITORS**

### Description

The ZXCT1082 and ZXCT1083 are high side unipolar current sense monitors. These devices eliminate the need to disrupt the ground plane when sensing a load current.

The ZXCT1082/1084/1086 have 60V maximum operating voltage and ZXCT1083/1085/1087 have 40V maximum operating voltage.

The wide common-mode input voltage range and low quiescent currents coupled with SOT25 packages make them suitable for a range of applications; including automotive and systems operating from industrial 24-28V rails.

Their quiescent current is only 0.6µA thereby minimizing current sensing error.

The ZXCT1082 and ZXCT1083 use three external transconductance/gain setting resistors which increase versatility by permitting wide gain ranges and optimization of bandwidths.

The ZXCT1084/5/6/7 are fixed gain voltage output counterparts of the ZXCT1082/3.

### Features

- Wide supply and common-mode voltage range
  - 2.7V to 60V ZXCT1082/84/86
  - 2.7V to 40V ZXCT1083/85/87
- Independent supply and input common-mode voltage
- Low quiescent current (0.6µA).
- AEC-Q100 Grade 1 qualified
- Extended industrial temperature range -40 to 125°C
- Package SOT25

### Applications

- Automotive current measurement
- Industrial applications current measurement
- Battery management
- Over current monitor
- Power Management
- Current sources

### Pin Assignments

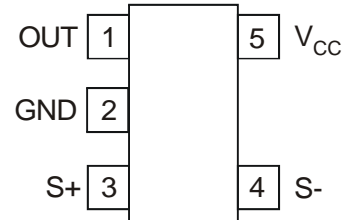

### Typical Application Circuits

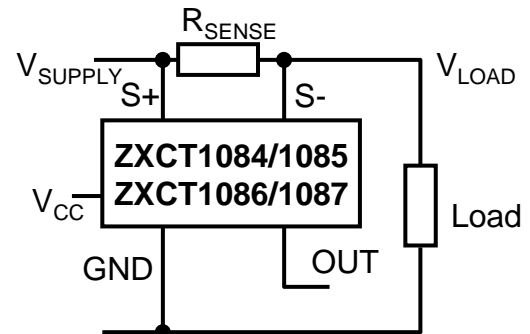

ZXCT1084/85:  $V_{OUT} = 25 \times V_{SENSE}$   
 ZXCT1086/87:  $V_{OUT} = 50 \times V_{SENSE}$

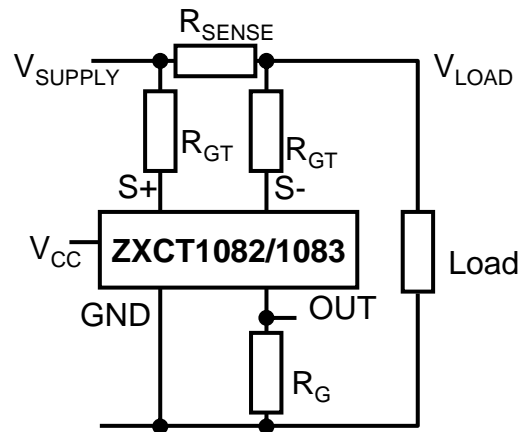

ZXCT1082/83:  $V_{OUT} = V_{SENSE} \times \frac{R_G}{R_{GT}}$

## Pin Description

PIN	Name	Description		
		Common	ZXCT1082/3	ZXCT1084/5/6/7
1	OUT	Output pin.	Current output.	Voltage output
2	GND	Ground pin.		
3	S+	This is the positive input of the current monitor. It has a wide common-mode input range. The current through this pin varies with differential sense voltage.	An external resistor, $R_{GT}$ , should be connected from S+ to the input side ( $V_{SUPPLY}$ ) of the sense resistor	Should be directly connected to the input side ( $V_{SUPPLY}$ ) of the sense resistor.
4	S-	This is the negative input of the current monitor. It has a wide common-mode input range.	An external resistor, $R_{GT}$ , should be connected from S- to the load side ( $V_{LOAD}$ ) of the sense resistor.	Should be directly connected to the load side ( $V_{LOAD}$ ) of the sense resistor.
5	$V_{CC}$	This is the analogue supply and provides power to internal circuitry.		

## Absolute Maximum Ratings

Parameter	Rating	Unit
Voltage on S- and S+		
ZXCT1082, ZXCT1084, ZXCT1086	-0.3 to 65	V
ZXCT1083, ZXCT1085, ZXCT1087	-0.3 to 45	
Voltage on $V_{CC}$		
ZXCT1082, ZXCT1084, ZXCT1086	-0.3 to 65	V
ZXCT1083, ZXCT1085, ZXCT1087	-0.3 to 45	
Voltage on OUT	-0.3 to $V_{S-}$	V
Differential Input Voltage, $V_{S+} - V_{S-}$	$\pm 800$	mV
Input current into S+ or S- <sup>(f)</sup>	$\pm 12$	mA
Storage Temperature	-55 to 150	°C
Maximum Junction Temperature	150	°C
Package Power Dissipation	300 at $T_A = 25^\circ\text{C}$ (De-rate to zero at $150^\circ\text{C}$ )	mW
<b>ESD Rating</b>		
Human Body Model	2	kV
Machine Model	200	V

Operation above the absolute maximum rating may cause device failure. Operation at the absolute maximum ratings, for extended periods, may reduce device reliability.

<sup>(f)</sup> The differential input voltage limit,  $V_{S+} - V_{S-}$ , may be exceeded provided that the input current limit into S+ or S- is not exceeded

## Recommended Operating Conditions

Symbol	Parameter	Min	Max	Units
$V_{IN}$	ZXCT1083/1085/1087 Common-Mode Input Range	2.7	40	V
	ZXCT1082/1084/1086 Common-Mode Input Range	2.7	60	
$V_{CC}$	ZXCT1083/1085/1087 Supply Voltage Range	2.7	40	V
	ZXCT1082/1084/1086 Supply Voltage Range	2.7	60	
$V_{SENSE}$	Differential Sense Input Voltage Range	0	0.5	V
$V_{OUT}$	Output Voltage Range	0	$V_{S-} - 1$	V
$T_A$	Ambient Temperature Range	-40	125	°C

## Electrical Characteristics

Test Conditions  $T_A = 25^\circ\text{C}$ ,  $V_{S+} = 12\text{V}$ ,  $V_{CC} = 5\text{V}$ ,  $V_{SENSE}^1 = 100\text{mV}$ , ZXCT1082/3  $R_{GT} = 5\text{k}\Omega$ ,  $R_G = 125\text{k}\Omega$ ; unless otherwise stated.  
(FT =  $-40^\circ\text{C}$  to  $+125^\circ\text{C}$ )

Symbol	Parameter	Conditions	Min.	Typ.	Max.	Units
<b>Input</b>						
$I_{S+}$	S+ input current	$V_{SENSE} = 0\text{mV}$ (Note 1)		1.7		$\mu\text{A}$
			$T_A = \text{FT}$		5	
$I_{S-}$	S- input current	$V_{SENSE} = 0\text{mV}$ (Note 1)		1.7		$\mu\text{A}$
			$T_A = \text{FT}$		5	
$V_{IO}$	Input Offset Voltage (Note 2)	$V_{SENSE} = 0\text{mV}$		$\pm 0.2$	$\pm 1$	mV
		ZXCT1082/3/4/5	$T_A = \text{FT}$		$\pm 2.5$	
		ZXCT1086/87	$T_A = \text{FT}$		$\pm 3$	
		Temperature co-efficient				$\pm 4$
<b>Output</b>						
$G_T$	Transconductance			200		$\mu\text{A/V}$
$G_{T-ERR}$	Transconductance error (Note 4)	ZXCT1082/3 $V_{SENSE} = 10\text{mV}$ to $150\text{mV}$ (Note 1, 3)		-1	+1	%
			$T_A = \text{FT}$	-2	+2	
$G_{T-TC}$	Transconductance temperature co-efficient		$T_A = \text{FT}$	10		nA/K
$Z_{OUT}$	Output impedance	ZXCT1082/3		1115		$\text{G}\Omega/\mu\text{F}$
$G_V$	Gain	ZXCT1084/5/6/7 $V_{SENSE} = 10\text{mV}$ to $150\text{mV}$ (Note 1)	1084/5		25	V/V
			1086/7		50	
$G_{V-ERR}$	Gain error (Note 4)	ZXCT1084/5/6/7 $V_{SENSE} = 10\text{mV}$ to $150\text{mV}$ (Note 1)		-1	+1	%
			$T_A = \text{FT}$	-2	+2	
$G_{V-TC}$	Voltage gain temperature co-efficient		$T_A = \text{FT}$	100		ppm/K
$Z_{OUT}$	Output impedance	ZXCT1084/5/6/7		125		k $\Omega$
$V_{OUTH}$	Output relative to common mode, $V_{S-}$	ZXCT1082/3	$V_{LOAD} - 1$	$V_{LOAD}$ - 0.8		V
		ZXCT1084/5/6/7	$V_{S-} - 1$	$V_{S-} - 0.8$		

- Notes:
1. For the ZXCT1082/83  $V_{SENSE} = "V_{SUPPLY}" - "V_{LOAD}"$  where  $V_{LOAD}$  is the load voltage or the lower potential side of the sense resistor.  
For the ZXCT1083/84/85/86  $V_{SENSE} = "V_{S+}" - "V_{S-}"$
  2.  $V_{IO}$  is extrapolated from measurements for the gain-error test.
  3. For  $V_{SENSE} > 10\text{mV}$ , the internal voltage-current converter is fully linear. This enables a true offset to be defined and used.
  4. Gain or transconductance error is calculated by applying two values of  $V_{SENSE}$  and calculating the error of the slope vs. the ideal.

**Electrical Characteristics (cont.)**

Test Conditions  $T_A = 25^\circ\text{C}$ ,  $V_{S+} = 12\text{V}$ ,  $V_{CC} = 5\text{V}$ ,  $V_{SENSE}^1 = 100\text{mV}$ , ZXCT1082/3  $R_{GT} = 5\text{k}\Omega$ ,  $R_G = 125\text{k}\Omega$ ; unless otherwise stated.  
(FT =  $-40^\circ\text{C}$  to  $+125^\circ\text{C}$ )

Symbol	Parameter	Conditions	Min.	Typ.	Max.	Units
<b>AC characteristics</b>						
BW	-3dB Small Signal Bandwidth	$V_{SENSE(AC)} = 10\text{mV}_{PP}$ (Note 1)	G = 25	500		kHz
			G = 50	200		
$t_{s(0.1\%)}$	Settling time (0.1%)	$V_{SENSE} = 50\text{mV}$ to 300mV step	G = 25	5		$\mu\text{s}$
		$V_{SENSE} = 50\text{mV}$ to 200mV step	G = 50	7		
$i_{N-OUT}$	Output noise current density	f = 1kHz f = 10kHz	ZXCT1082/3	12 10		$\text{pA}/\sqrt{\text{Hz}}$
	Total output noise current	f = 0.1Hz to 100kHz		3		$\text{nA}_{RMS}$
$V_{N-OUT}$	Output noise voltage density	f = 1kHz	ZXCT1084/5	1.5		$\mu\text{V}/\sqrt{\text{Hz}}$
			ZXCT1086/7	2.9		
		f = 10kHz	ZXCT1084/5 ZXCT1086/7	1.2 2.3		
	Total output noise voltage	f = 0.1Hz to 100kHz	ZXCT1084/5 ZXCT1086/7	390 730		$\mu\text{V}_{RMS}$
<b>Power Supply</b>						
$I_{CC}$	$V_{CC}$ Supply current	$V_{SENSE} = 0\text{V}$			0.6	$\mu\text{A}$
			$T_A = FT$		2	
PSRR (Note 5)	$V_{CC}$ Supply rejection ratio	ZXCT1083/5: $V_{SENSE} = 60\text{mV}$ ; $V_{CC} = 2.7\text{V}$ to 40V	$T_A = FT$	80	100	dB
		ZXCT1087: $V_{SENSE} = 30\text{mV}$ ; $V_{CC} = 2.7\text{V}$ to 40V	$T_A = FT$	75	100	
		ZXCT1082/4: $V_{SENSE} = 60\text{mV}$ ; $V_{CC} = 2.7\text{V}$ to 60V	$T_A = FT$	80	100	
		ZXCT1086: $V_{SENSE} = 30\text{mV}$ ; $V_{CC} = 2.7\text{V}$ to 60V	$T_A = FT$	75	100	
			$T_A = FT$	80	100	
			$T_A = FT$	75	100	
CMRR (Note 5)	Common-mode sense rejection ratio	ZXCT1083/5: $V_{SENSE} = 60\text{mV}$ ; $V_{S+} = 2.7\text{V}$ to 40V	$T_A = FT$	80	100	dB
		ZXCT1087: $V_{SENSE} = 30\text{mV}$ ; $V_{S+} = 2.7\text{V}$ to 40V	$T_A = FT$	80	100	
		ZXCT1082/4: $V_{SENSE} = 60\text{mV}$ ; $V_{S+} = 2.7\text{V}$ to 60V	$T_A = FT$	80	100	
		ZXCT1086: $V_{SENSE} = 30\text{mV}$ ; $V_{S+} = 2.7\text{V}$ to 60V	$T_A = FT$	80	100	
			$T_A = FT$	80	100	
			$T_A = FT$	80	100	

Notes: 5. Measured relative to input

**Typical Characteristics**  $V_{S+} = 12V$ ,  $V_{CC} = 5V$ ,  $V_{SENSE} = 100mV$ ,  $R_{GT} = 5k\Omega$ ,  $R_G = 125k\Omega$ ,  $T_A = 25^\circ C$  unless otherwise stated

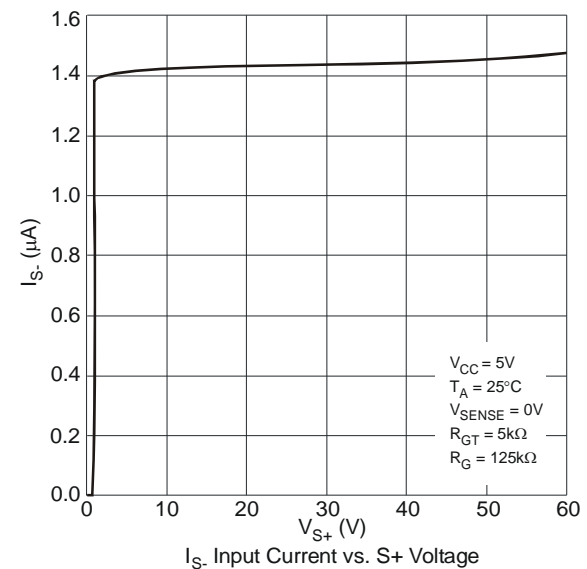
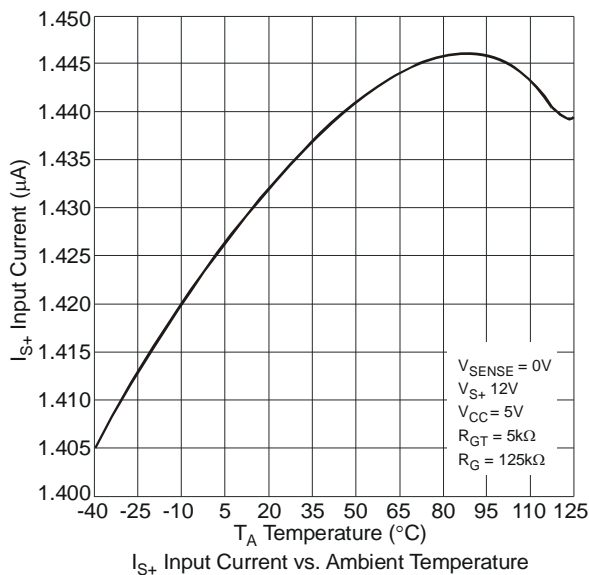
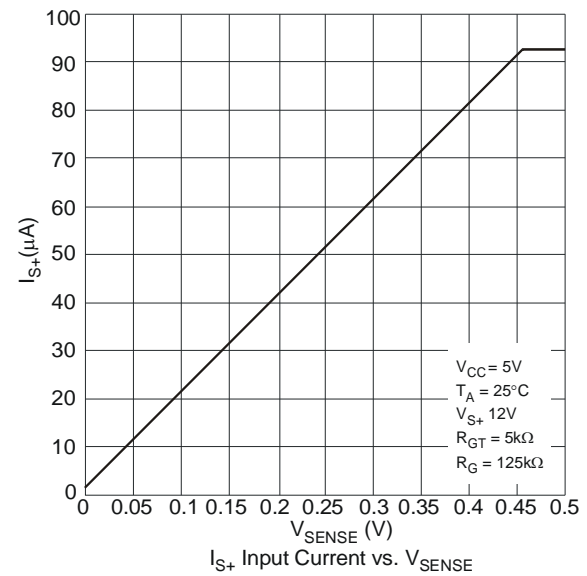
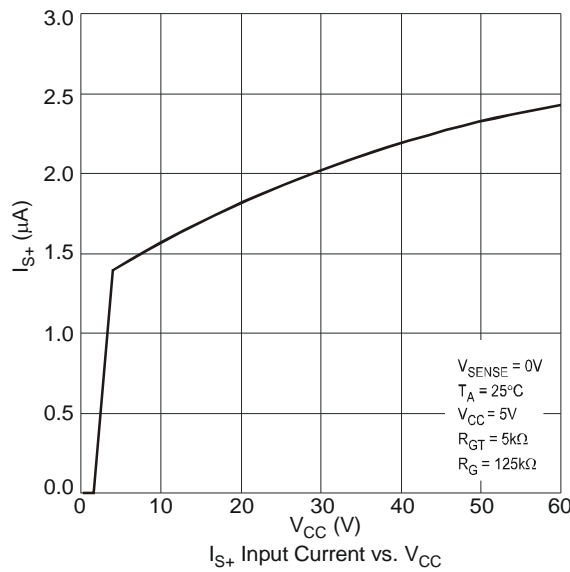
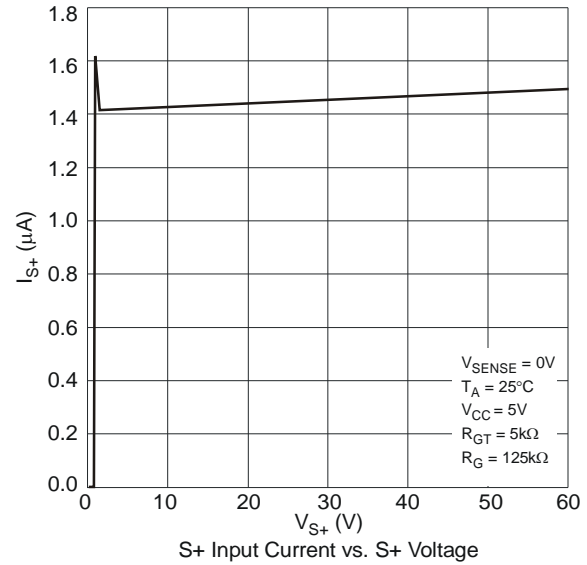
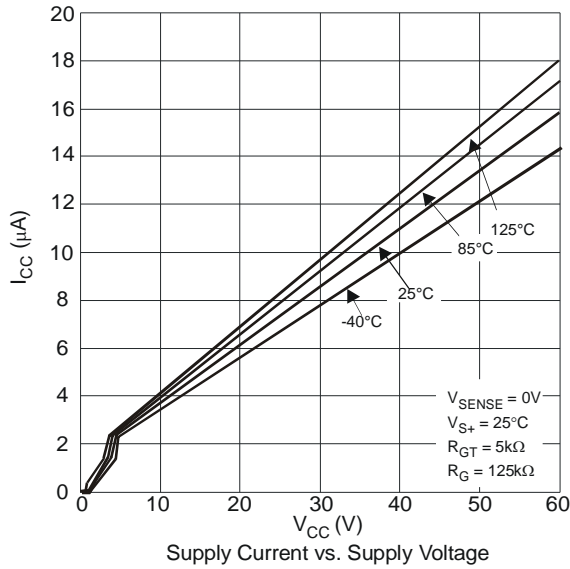

**Typical Characteristics (cont.)**  $V_{S+} = 12V$ ,  $V_{CC} = 5V$ ,  $V_{SENSE} = 100mV$ ,  $R_{GT} = 5k\Omega$ ,  $R_G = 125k\Omega$ ,  $T_A = 25^\circ C$

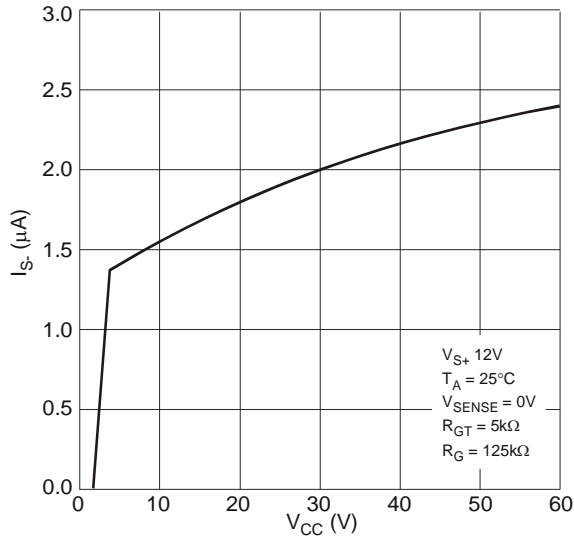

$I_S$ . Input Current vs. Supply Voltage

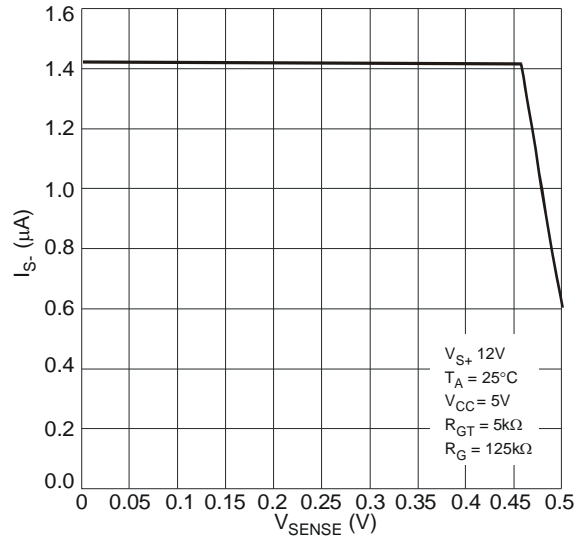

$I_S$ . Input Current vs.  $V_{SENSE}$  Different Voltage

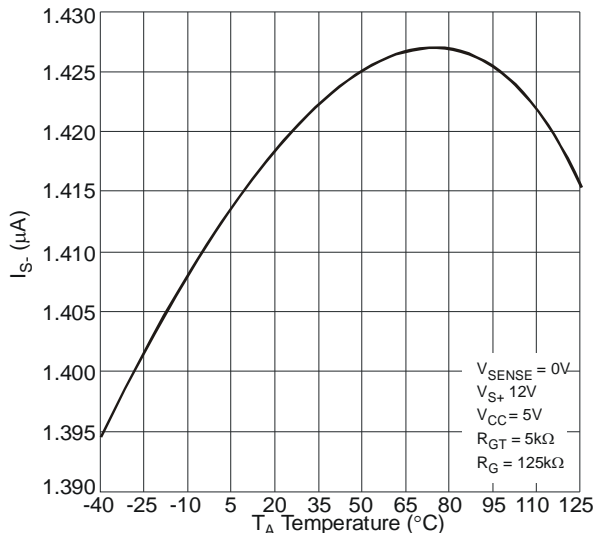

$I_S$ . Input Current vs. Ambient Temperature

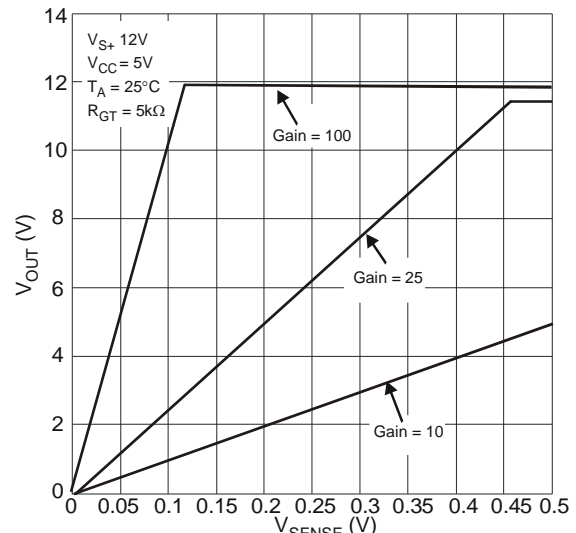

Output Voltage vs.  $V_{SENSE}$

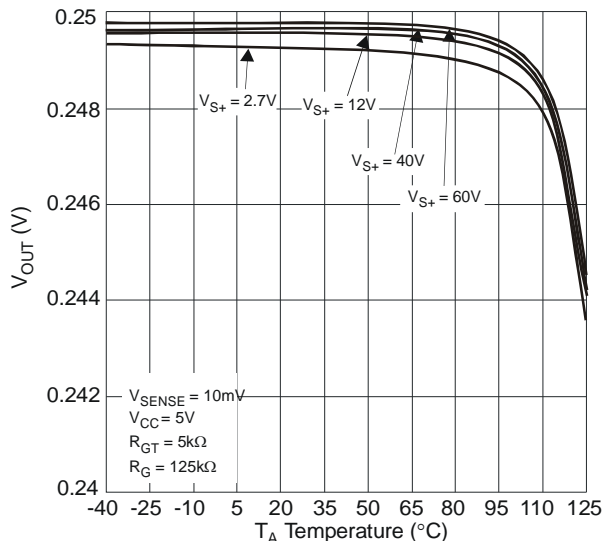

$V_{OUT}$  vs. Ambient Temperature

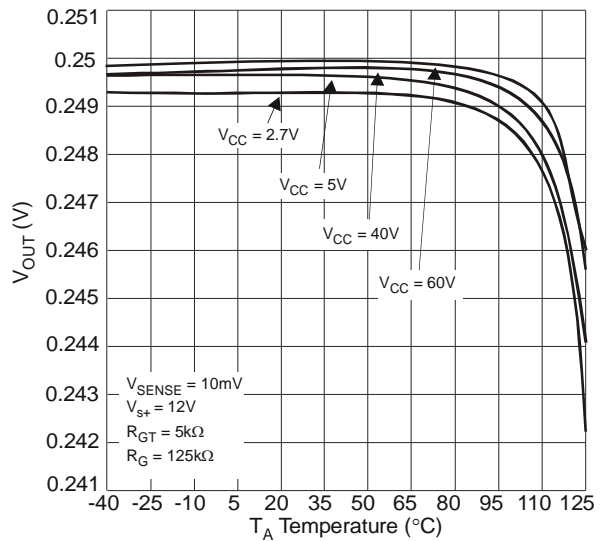

$V_{OUT}$  vs. Ambient Temperature

**Typical Characteristics (cont.)**  $V_{S+} = 12V$ ,  $V_{CC} = 5V$ ,  $V_{SENSE} = 100mV$ ,  $R_{GT} = 5k\Omega$ ,  $R_G = 125k\Omega$ ,  $T_A = 25^\circ C$

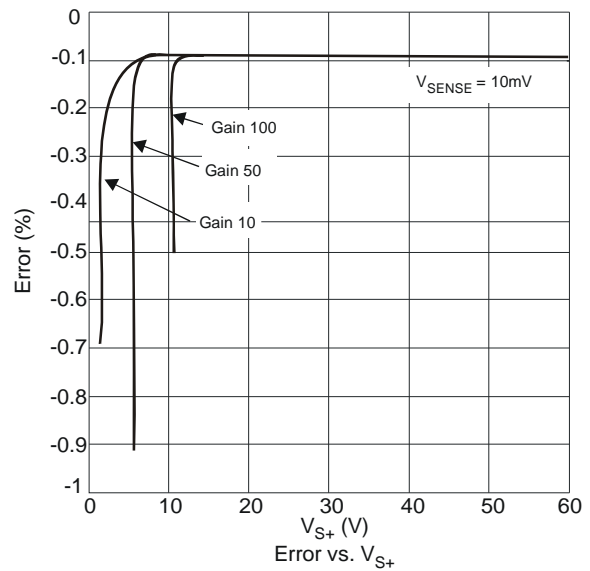
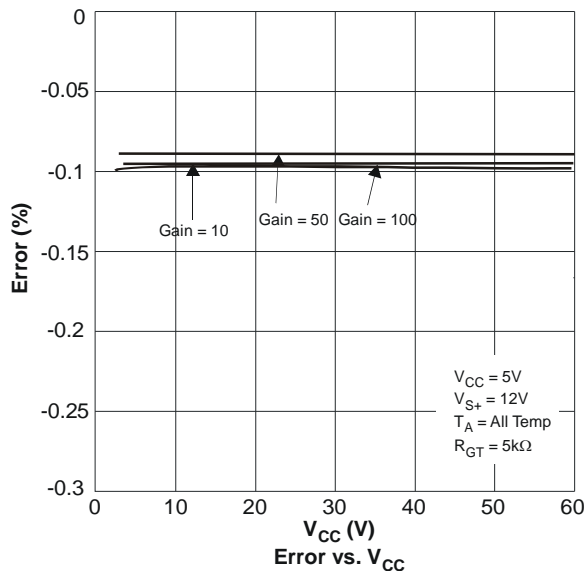
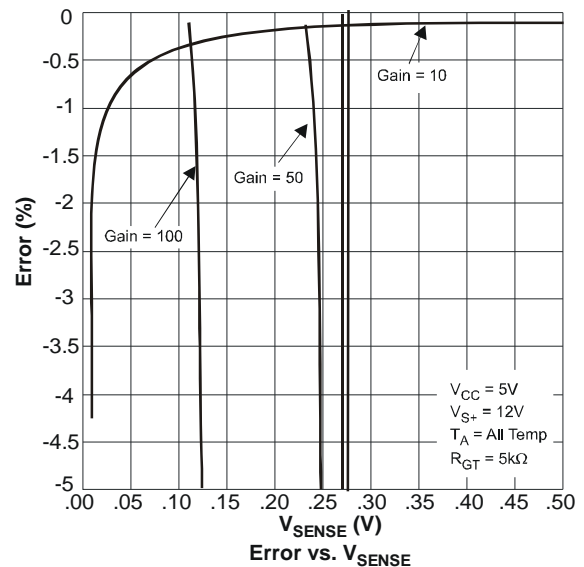
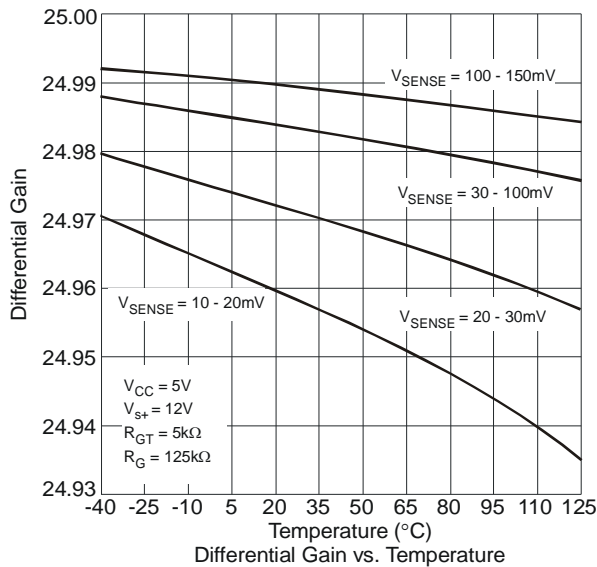
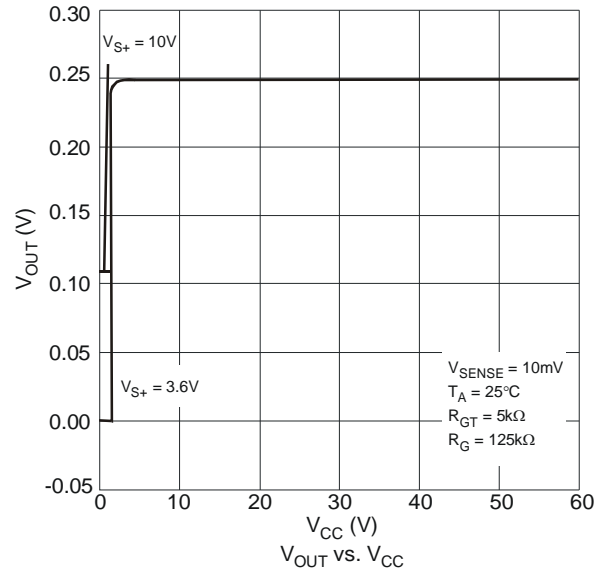
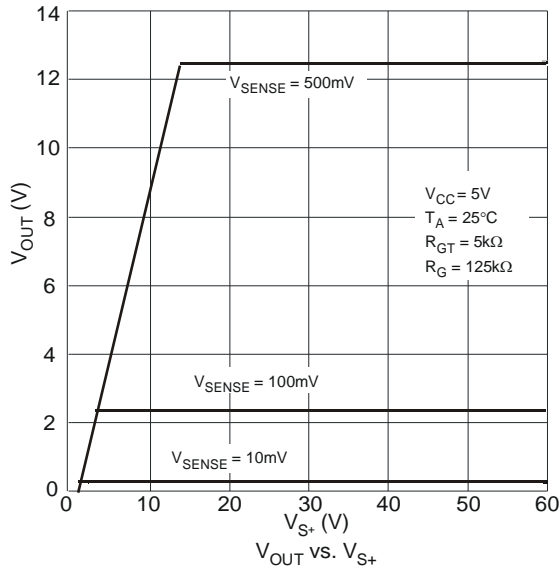

**Typical Characteristics (cont.)**  $V_{S+} = 12V$ ,  $V_{CC} = 5V$ ,  $V_{SENSE} = 100mV$ ,  $R_{GT} = 5k\Omega$ ,  $R_G = 125k\Omega$ ,  $T_A = 25^\circ C$

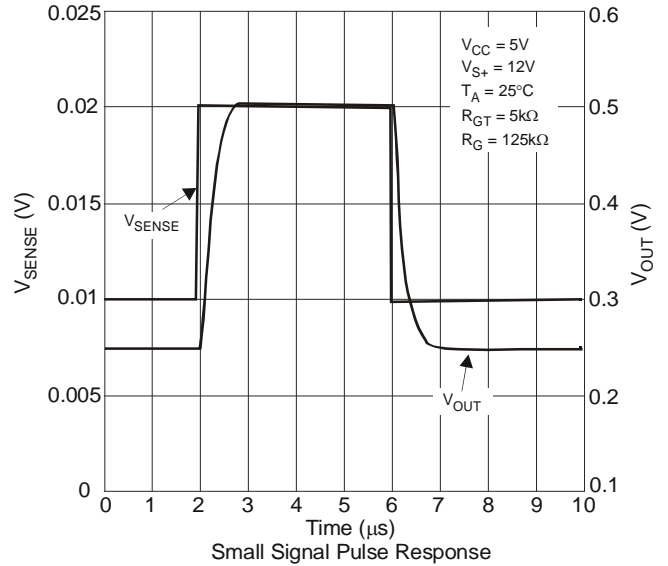
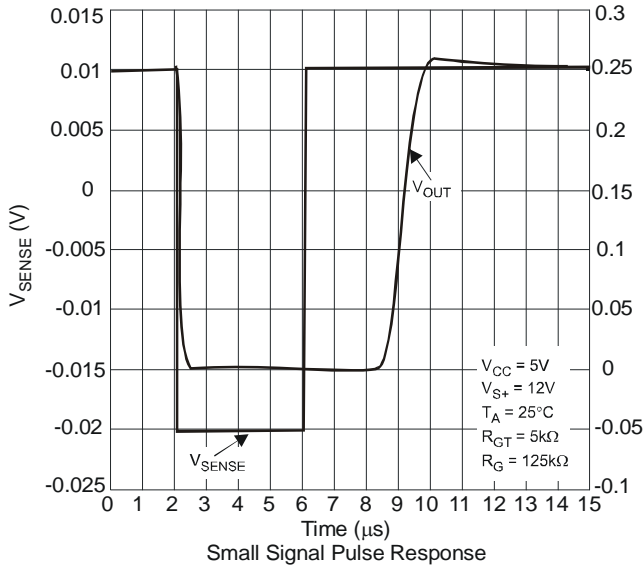
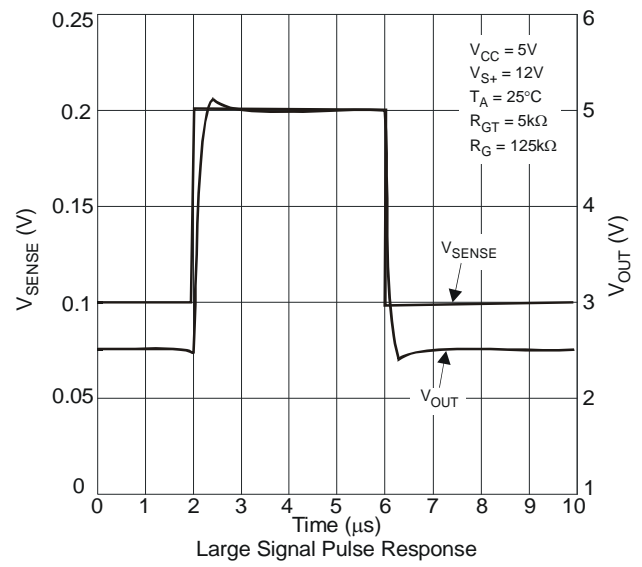
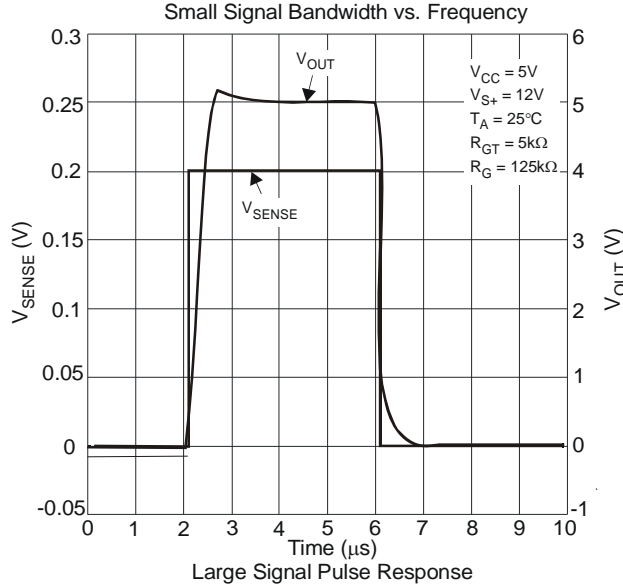
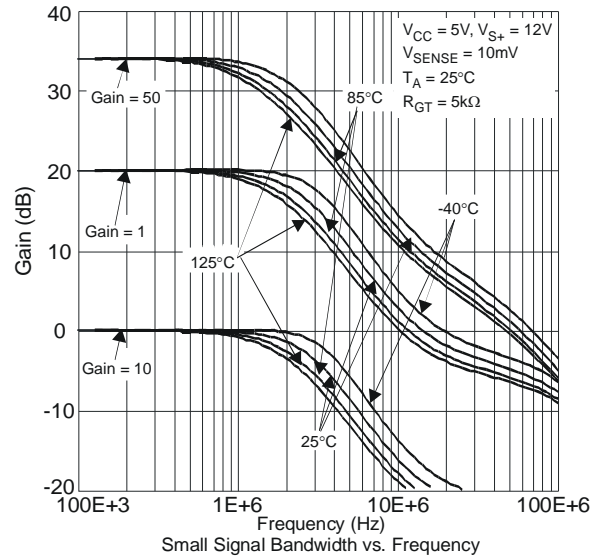
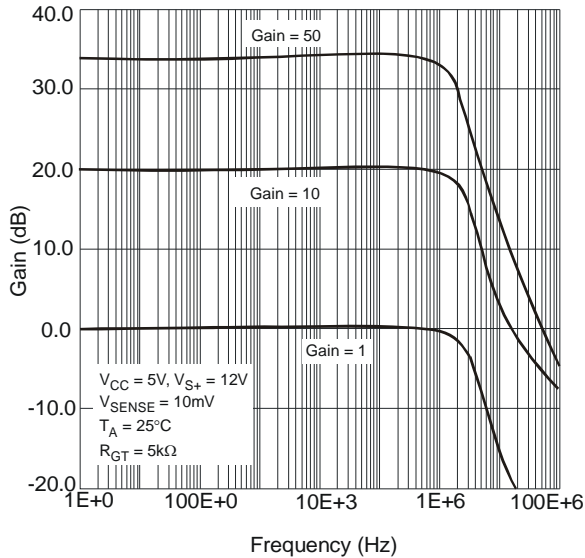



**Typical Characteristics (cont.)**  $V_{S+} = 12V$ ,  $V_{CC} = 5V$ ,  $V_{SENSE} = 100mV$ ,  $R_{GT} = 5k\Omega$ ,  $R_G = 125k\Omega$ ,  $T_A = 25^\circ C$

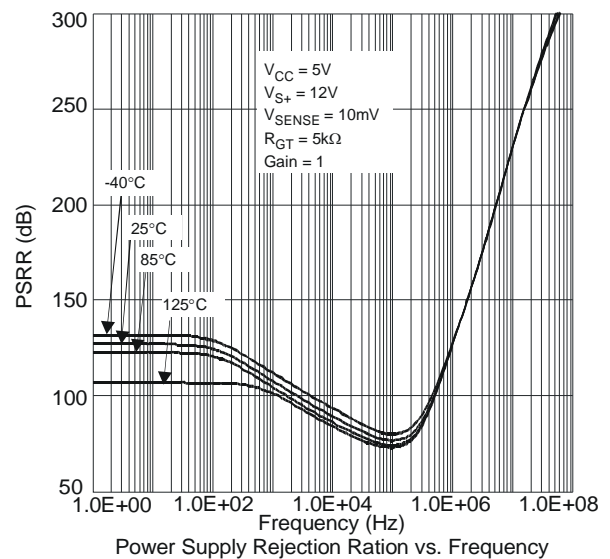
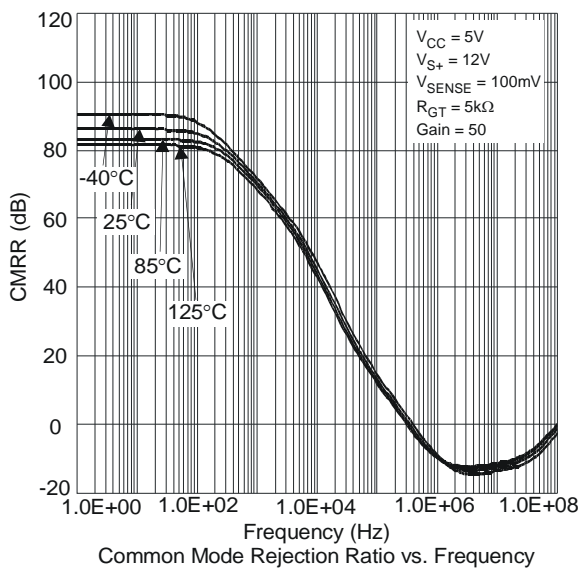
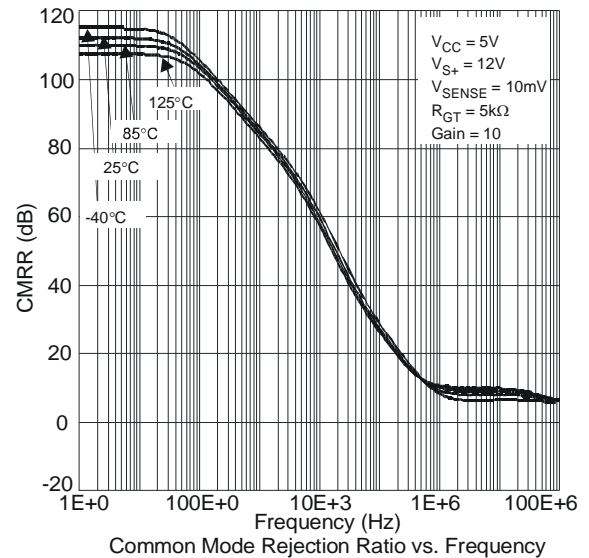
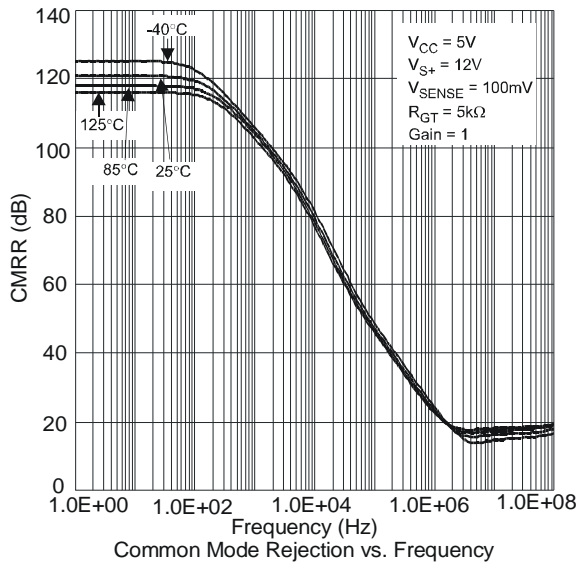
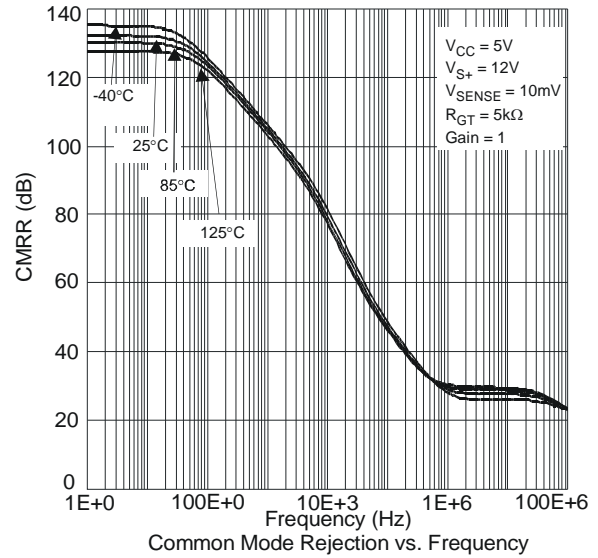
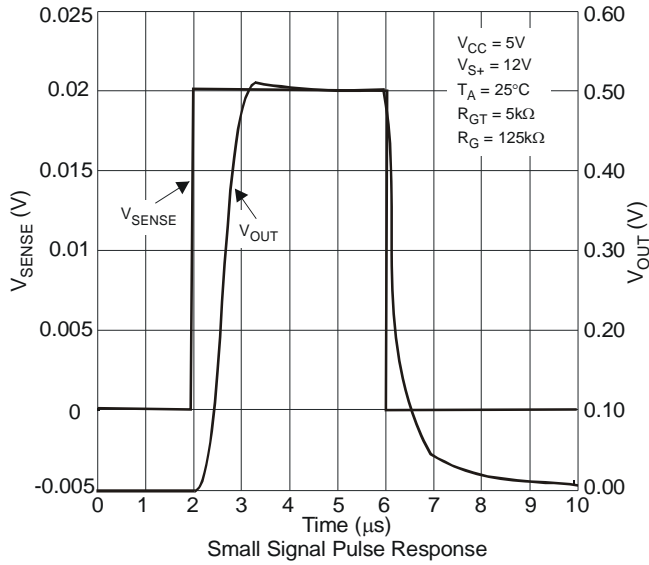

**Typical Characteristics (cont.)**  $V_{S+} = 12V$ ,  $V_{CC} = 5V$ ,  $V_{SENSE} = 100mV$ ,  $R_{GT} = 5k\Omega$ ,  $R_G = 125k\Omega$ ,  $T_A = 25^\circ C$

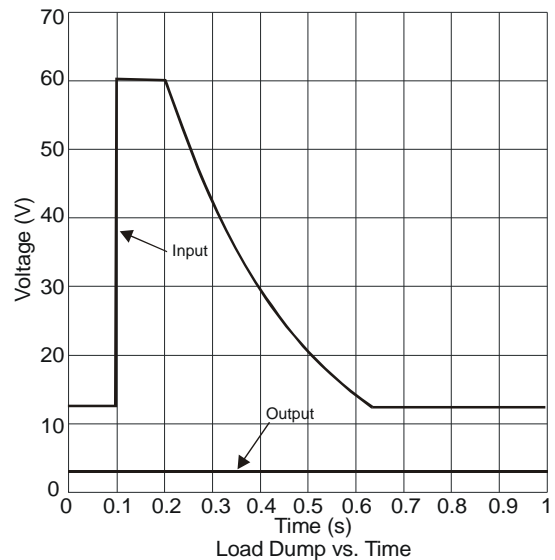
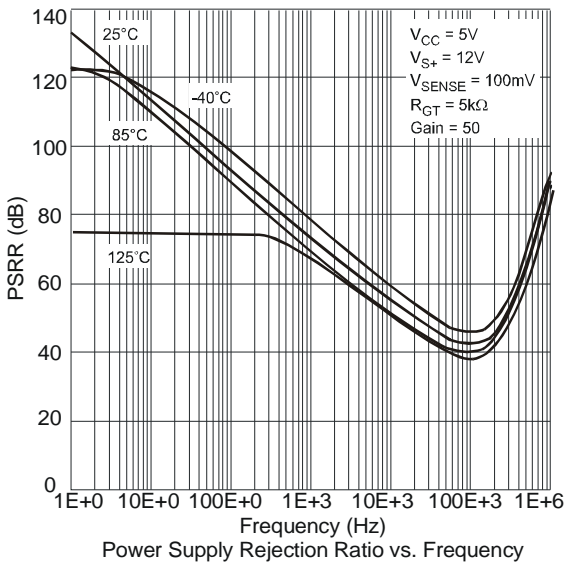
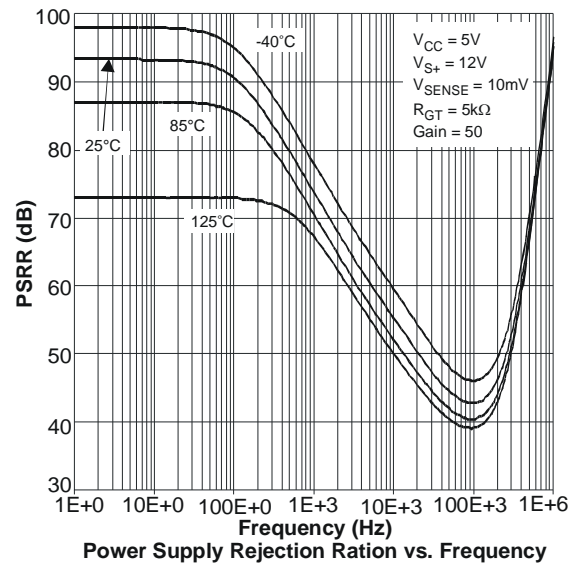
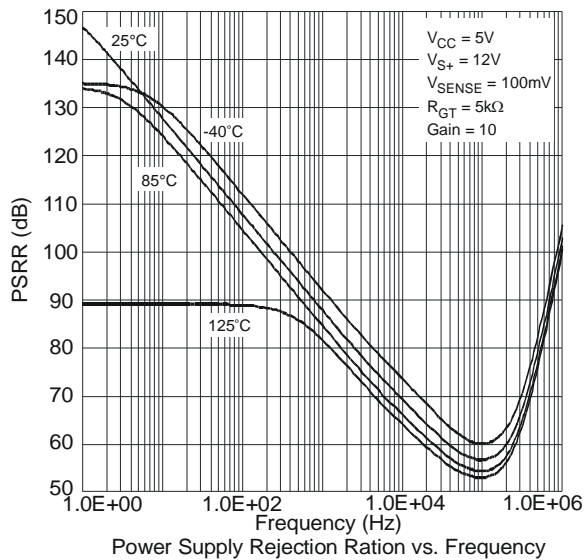
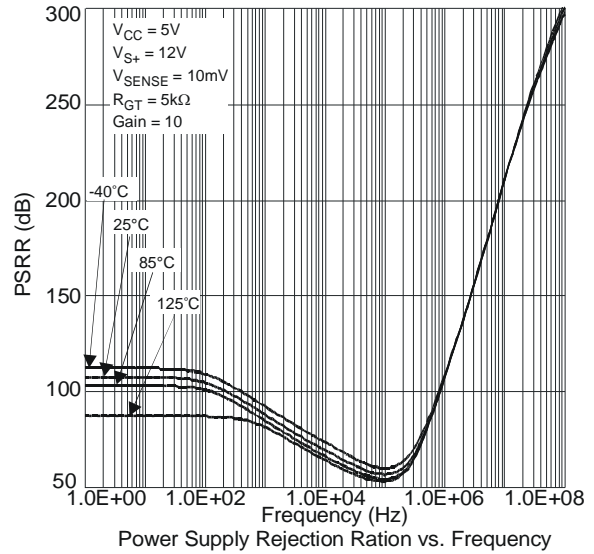
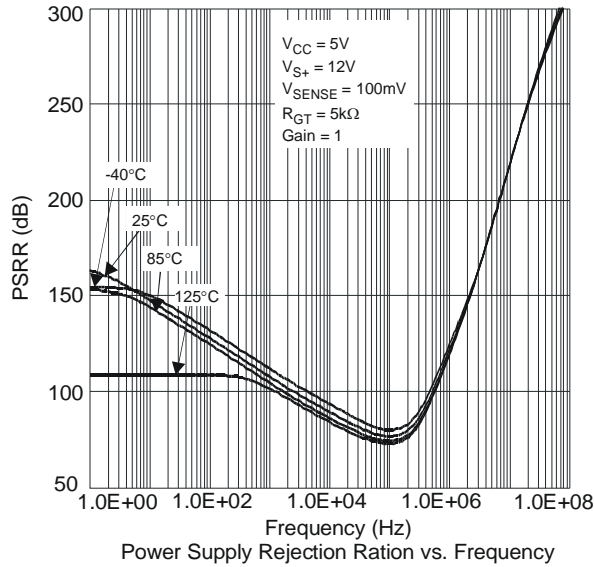

**Typical Characteristics (cont.)**  $V_{S+} = 12V$ ,  $V_{CC} = 5V$ ,  $V_{SENSE} = 100mV$ ,  $R_{GT} = 5k\Omega$ ,  $R_G = 125k\Omega$ ,  $T_A = 25^\circ C$

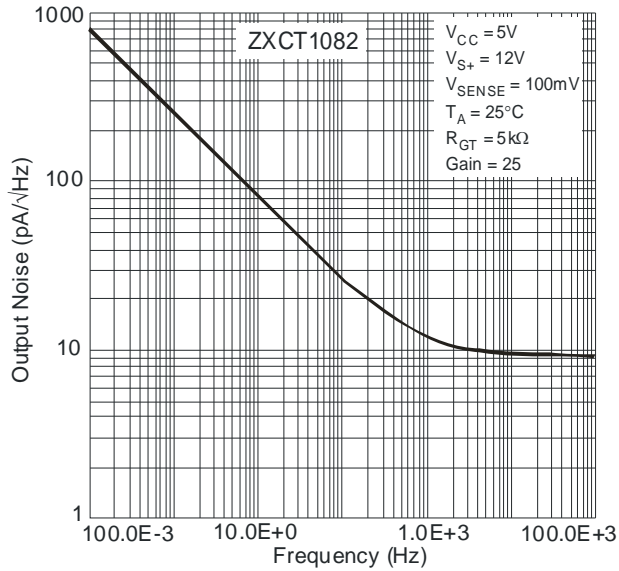

Output Noise Current vs. Frequency

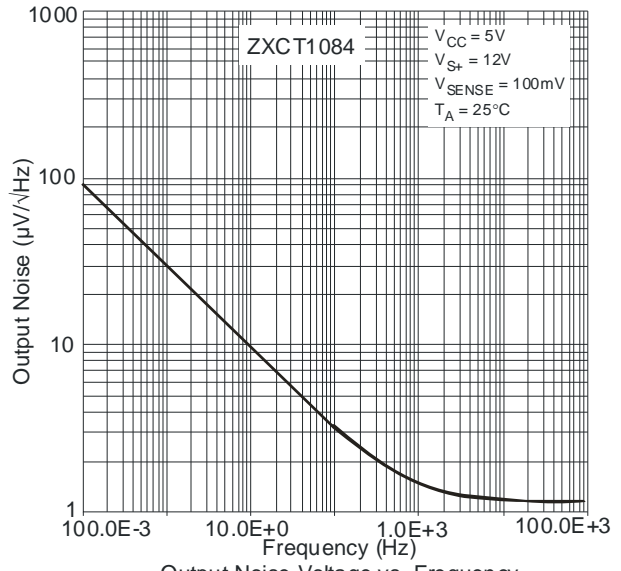

Output Noise Voltage vs. Frequency

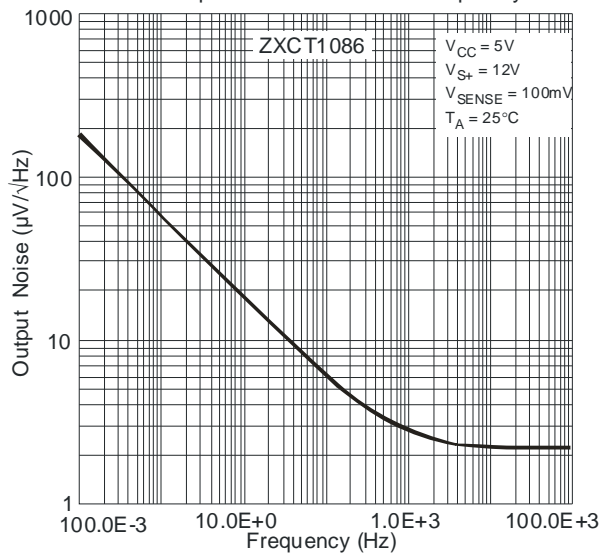

Output Noise Voltage vs. Frequency

**Ordering Information**

Part Number	AEC-Q100	Pack	Part mark	Reel Size	Tape width	Quantity per reel
ZXCT1082E5TA	Grade 1	SOT25	1082	7", 180mm	8mm	3000
ZXCT1083E5TA	Grade 1	SOT25	1083	7", 180mm	8mm	3000
ZXCT1084E5TA	Grade 1	SOT25	1084	7", 180mm	8mm	3000
ZXCT1085E5TA	Grade 1	SOT25	1085	7", 180mm	8mm	3000
ZXCT1086E5TA	Grade 1	SOT25	1086	7", 180mm	8mm	3000
ZXCT1087E5TA	Grade 1	SOT25	1087	7", 180mm	8mm	3000

**Package Outline Dimensions**

**SOT25**

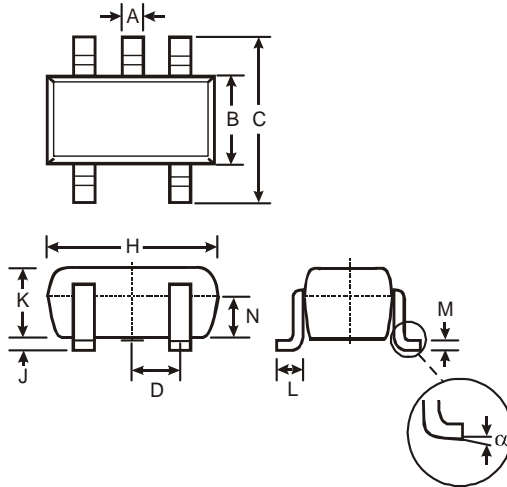

SOT25			
Dim	Min	Max	Typ
A	0.35	0.50	0.38
B	1.50	1.70	1.60
C	2.70	3.00	2.80
D	—	—	0.95
H	2.90	3.10	3.00
J	0.013	0.10	0.05
K	1.00	1.30	1.10
L	0.35	0.55	0.40
M	0.10	0.20	0.15
N	0.70	0.80	0.75
α	0°	8°	—
All Dimensions in mm			

**IMPORTANT NOTICE**

DIODES INCORPORATED MAKES NO WARRANTY OF ANY KIND, EXPRESS OR IMPLIED, WITH REGARDS TO THIS DOCUMENT, INCLUDING, BUT NOT LIMITED TO, THE IMPLIED WARRANTIES OF MERCHANTABILITY AND FITNESS FOR A PARTICULAR PURPOSE (AND THEIR EQUIVALENTS UNDER THE LAWS OF ANY JURISDICTION).

Diodes Incorporated and its subsidiaries reserve the right to make modifications, enhancements, improvements, corrections or other changes without further notice to this document and any product described herein. Diodes Incorporated does not assume any liability arising out of the application or use of this document or any product described herein; neither does Diodes Incorporated convey any license under its patent or trademark rights, nor the rights of others. Any Customer or user of this document or products described herein in such applications shall assume all risks of such use and will agree to hold Diodes Incorporated and all the companies whose products are represented on Diodes Incorporated website, harmless against all damages.

Diodes Incorporated does not warrant or accept any liability whatsoever in respect of any products purchased through unauthorized sales channel.

Should Customers purchase or use Diodes Incorporated products for any unintended or unauthorized application, Customers shall indemnify and hold Diodes Incorporated and its representatives harmless against all claims, damages, expenses, and attorney fees arising out of, directly or indirectly, any claim of personal injury or death associated with such unintended or unauthorized application.

Products described herein may be covered by one or more United States, international or foreign patents pending. Product names and markings noted herein may also be covered by one or more United States, international or foreign trademarks.

**LIFE SUPPORT**

Diodes Incorporated products are specifically not authorized for use as critical components in life support devices or systems without the express written approval of the Chief Executive Officer of Diodes Incorporated. As used herein:

A. Life support devices or systems are devices or systems which:

1. are intended to implant into the body, or
2. support or sustain life and whose failure to perform when properly used in accordance with instructions for use provided in the labeling can be reasonably expected to result in significant injury to the user.

B. A critical component is any component in a life support device or system whose failure to perform can be reasonably expected to cause the failure of the life support device or to affect its safety or effectiveness.

Customers represent that they have all necessary expertise in the safety and regulatory ramifications of their life support devices or systems, and acknowledge and agree that they are solely responsible for all legal, regulatory and safety-related requirements concerning their products and any use of Diodes Incorporated products in such safety-critical, life support devices or systems, notwithstanding any devices- or systems-related information or support that may be provided by Diodes Incorporated. Further, Customers must fully indemnify Diodes Incorporated and its representatives against any damages arising out of the use of Diodes Incorporated products in such safety-critical, life support devices or systems.

Copyright © 2011, Diodes Incorporated

[www.diodes.com](http://www.diodes.com)